

Asennusaika
5 h/2hlö

Ikäsuositus
+1

Korkeus
2590 mm

Käyttäjjiä
kerralla
8

Leveys
3200 mm

Pituus
3390 mm





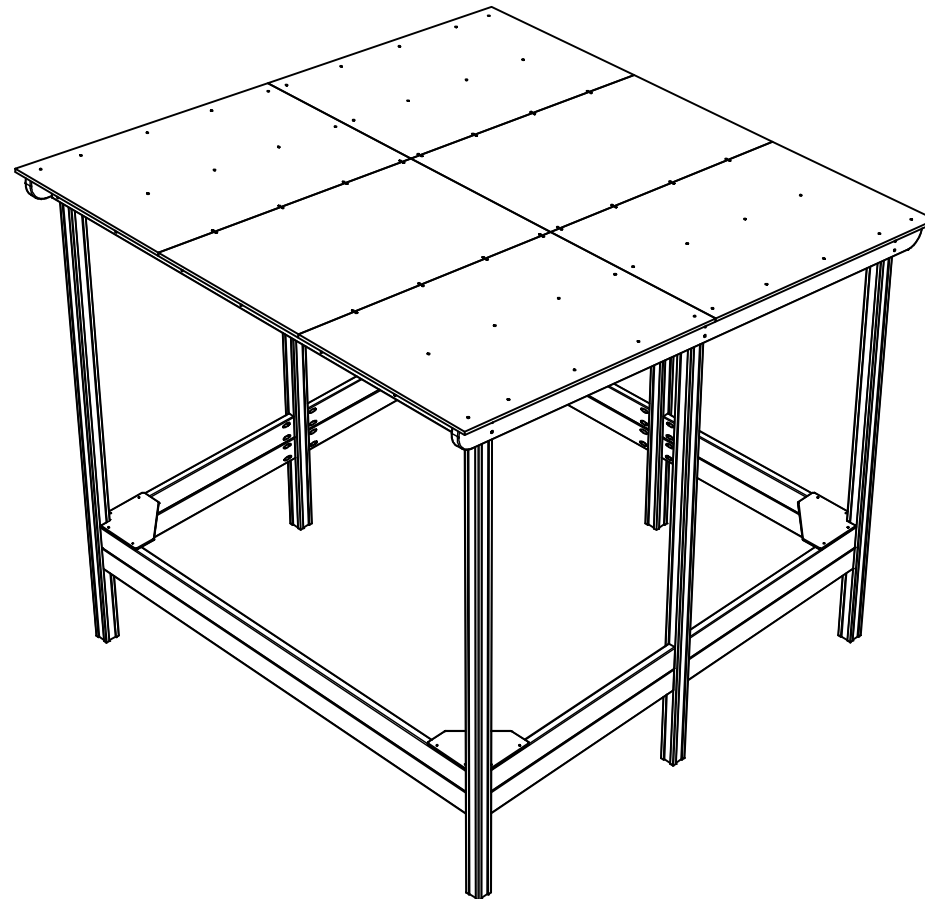

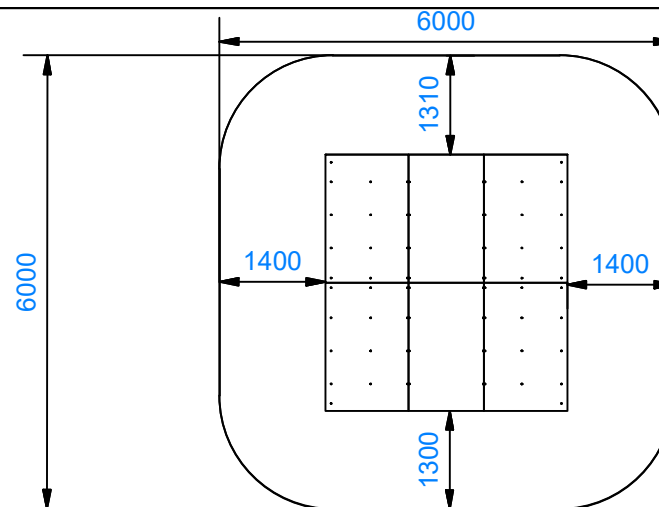
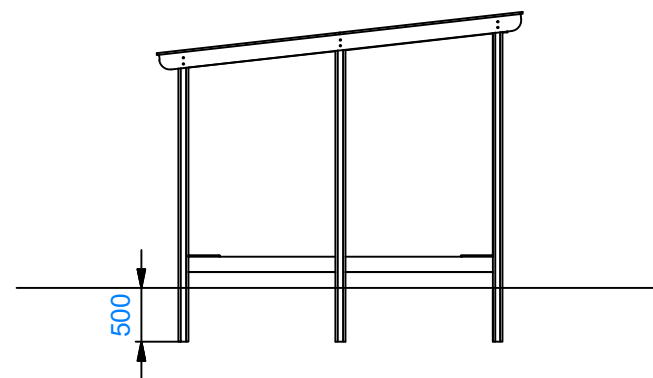
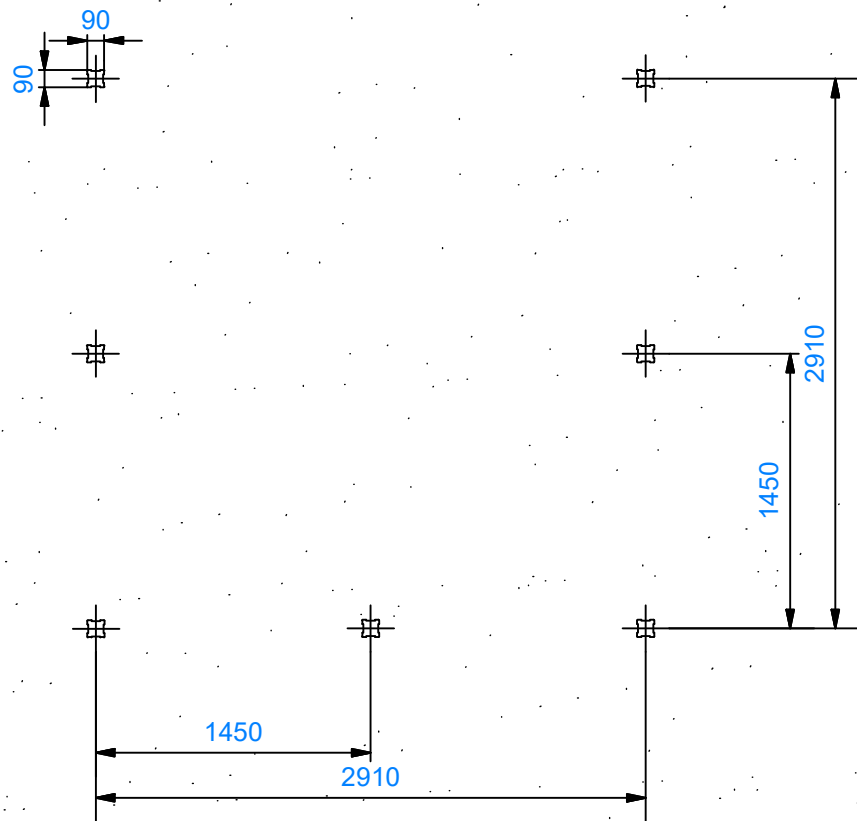

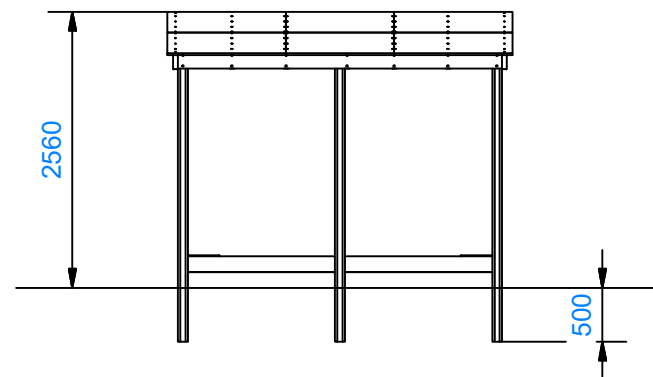
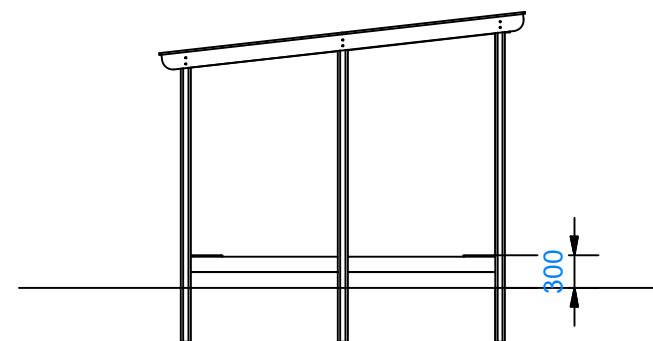
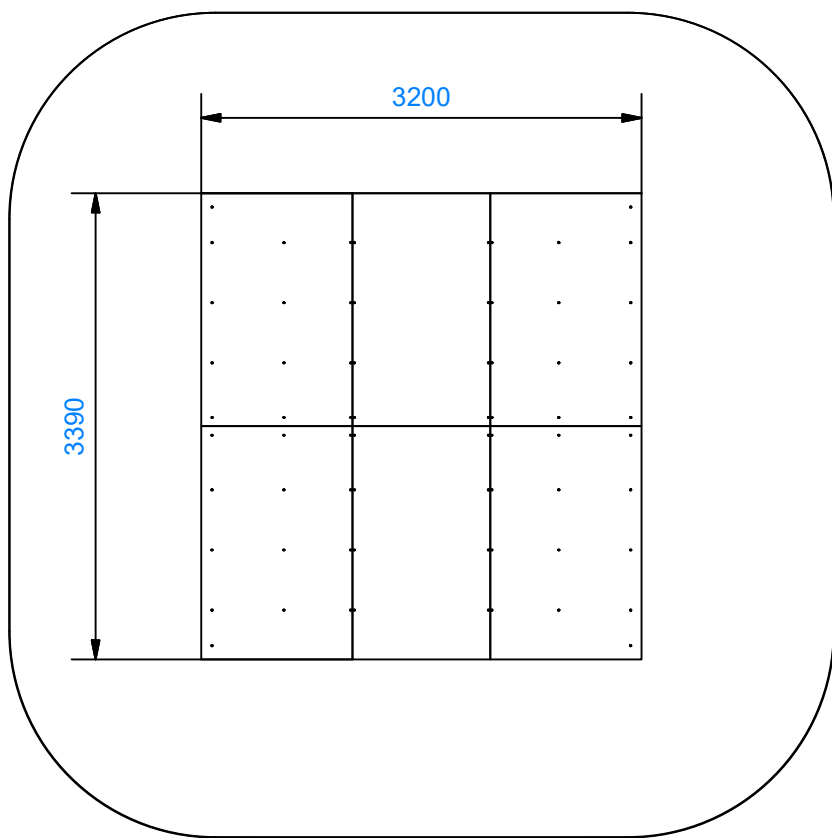











Maksimi
putoamiskorkeus
300 mm

Turva-alue
34 m²







HL-00155 4 	PU-00292 1 	PU-00287 2 	PU-00288 2 	PU-00289 4 	VA-00104 2 	VA-00105 2 	VA-00106 2 	PU-00290 2 	
M00461 6  	PU-00286 3 	PU-00285 2 	M00174 1  	RU-00044 88 	RU-00014 14 	RU-00047 14 	RU-00002 28 	MA-00001 5 NO PIC	
MA-00002 1 NO PIC	MU007 14 	RU-00089 1 							

Tukipuiden asennus

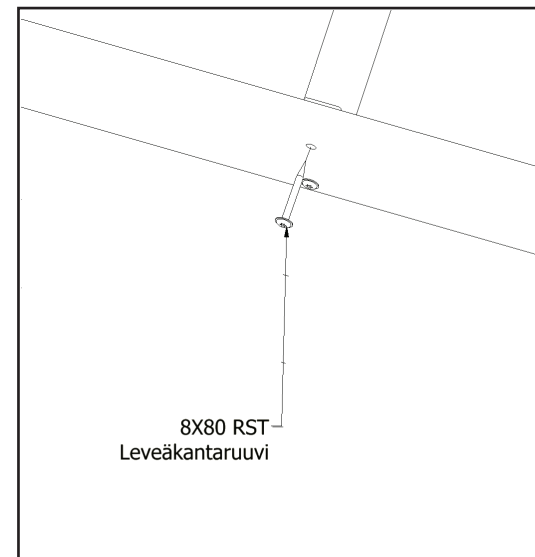
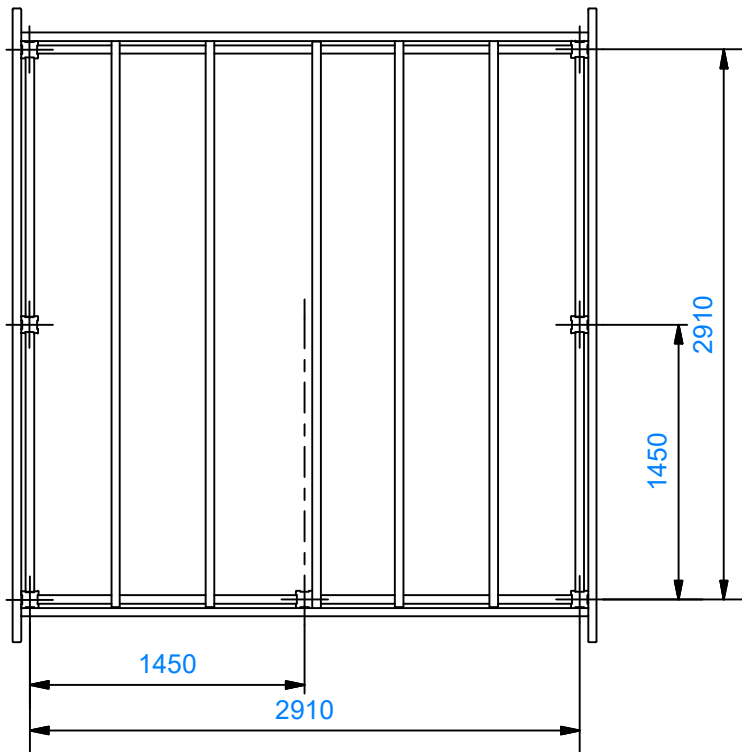

Tukipuiden sekä kattovanerin asennus

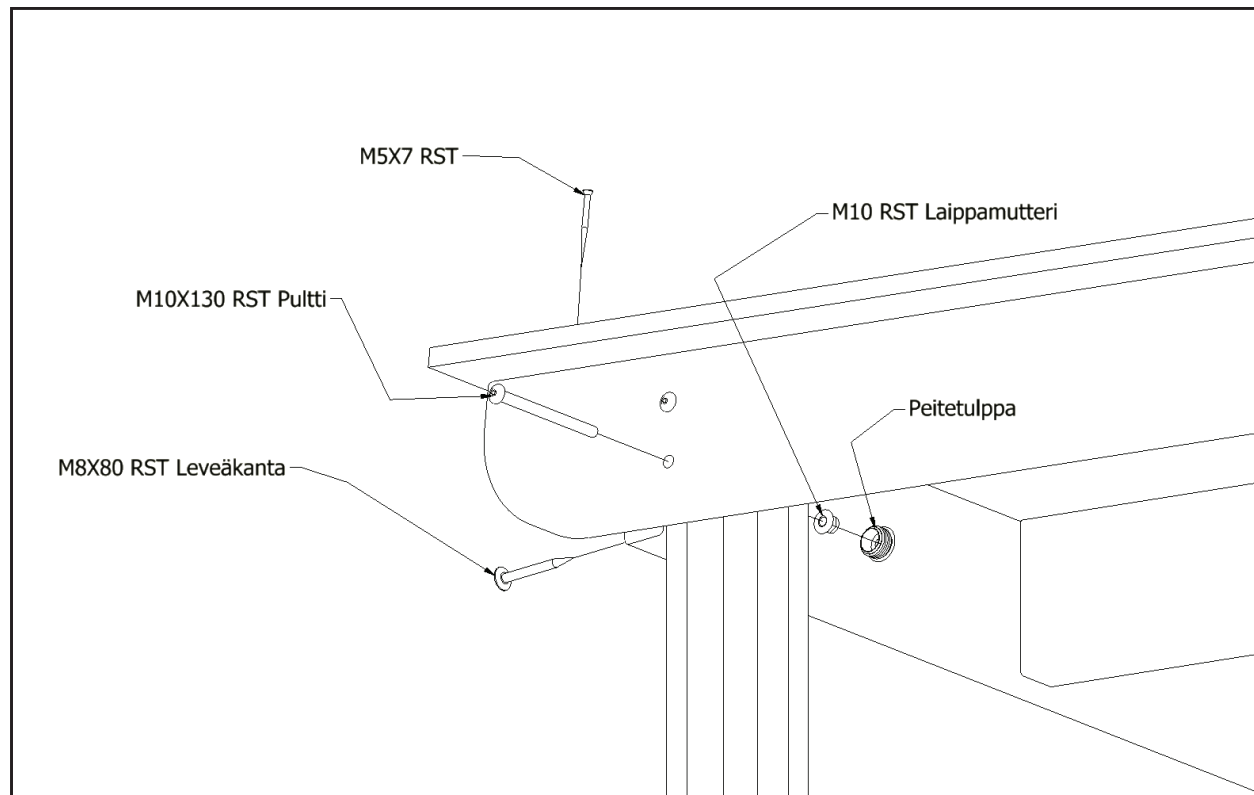

Laitojen kiinnittäminen

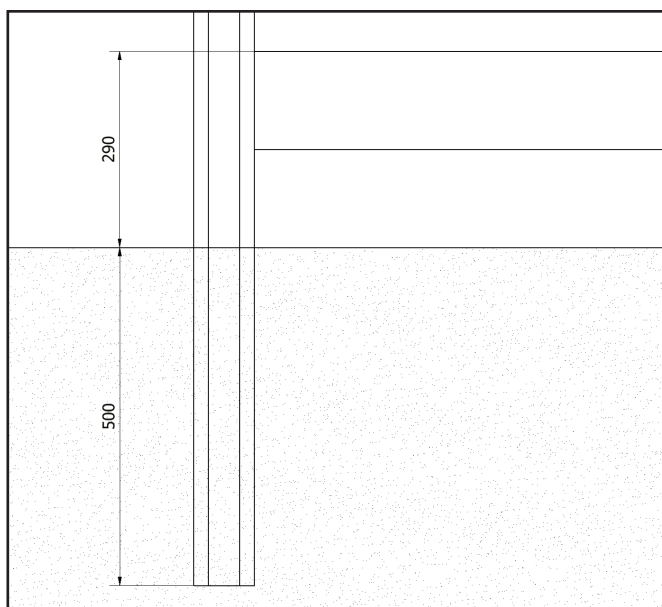

Tolpat asennetaan
500 mm syvyyteen.

Laitojen kiinnittäminen

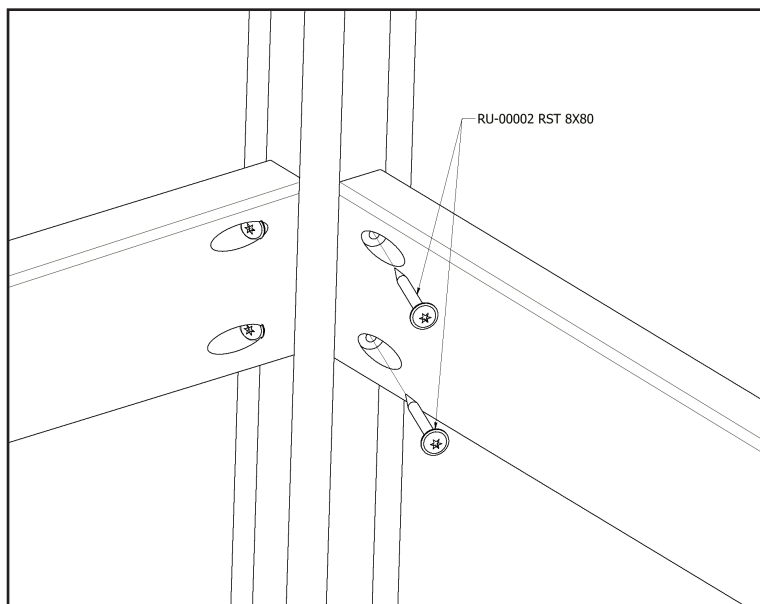

Kiinnike kiinnitetään
sisäpuolelle.

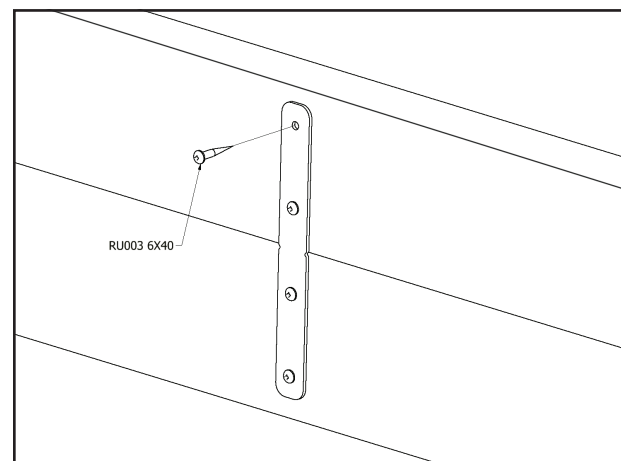

Istuinlevyn kiinnittäminen

