

Pituus
4350 mm

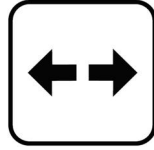







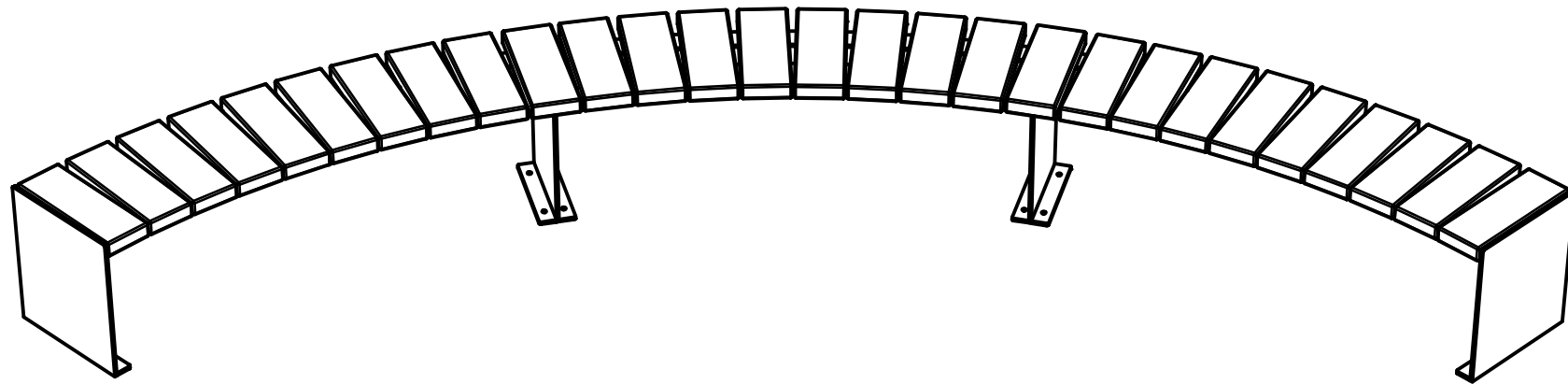

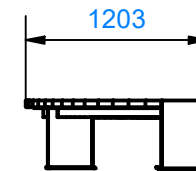
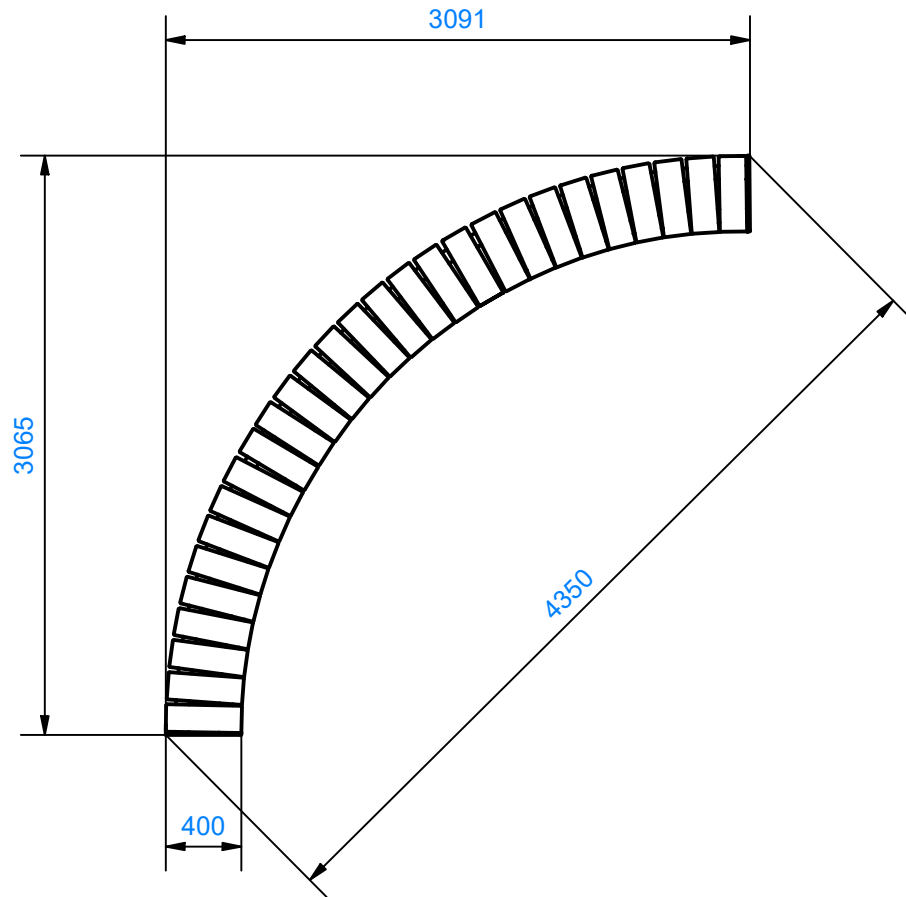
Korkeus
450 mm



Leveys
1200 mm





| | | | | | | | | | | | | | |
|---|---|---|---|---|---|---|---|---|---|---|---|---|---|
| M00385 | 1 | M00387 | 1 | ME-01124 | 2 | PU-00259 | 2 | ME-01078 | 2 | M00542 | 1 | M00529 | 3 |
|  | |  | |  | |  | |  | |  | |  | |

Penkin jalkojen kiinnitys

